



3D Printer User Manual

V1.0

Dear Consumers,

Thank you for choosing our products. For the best experience, please read the instructions before operating the Printer. Our teams are always ready to render you the best services. Please contact us via the phone number or e-mail address provided at the end when you encounter any problem with the Printer.

For a better experience in using our product, you can also access how to use the printer in the following ways:

View the accompanied instructions and videos in the U disk.

Visit our official website www.creality.com to find relevant software/hardware information, contact details and operation and maintenance instructions.

Firmware/Software Downloads and Upgrades

The product has access to both LycheeSlicer and CHITUBOX. WiFi printing and access to the Creative Cloud are under development.

Slicing software supported:   

Download the firmware and HALOT BOX slicing software at: <https://www.creality.com>

Download the CHITUBOX slicing software at: <https://www.chitubox.com>

Download the LycheeSlicer slicing software at: <https://lychee.mango3d.io>

- ❶ Do not use the printer any way other than described to avoid personal injury or property damage.
- ❷ Do not place the printer near any heat source or flammable or explosive objects. We suggest placing it in a well-ventilated, low-dust environment.
- ❸ Do not expose the printer to violent vibration or any unstable environment, as this may cause poor print quality.
- ❹ Please use recommended resin in case damage to machine.
- ❺ Do not use any other power cable except the one supplied. Always use a grounded three-prong power outlet.
- ❻ Please do not open the plastic cover during usage, otherwise the printing will be interrupted.
- ❼ Do not wear cotton gloves when operating the printer. Such cloths may become tangled in the printers moving parts leading to burns, possible bodily injury, or printer damage.
- ❽ Please wait after the print is finished. please wear gloves to take out the print tools.
- ❾ Clean the printer frequently. Always turn the power off when cleaning, and wipe with a dry cloth to remove dust, adhered printing plastics or any other material off the frame, guide rails, or wheels. Use glass cleaner or isopropyl alcohol to clean the print surface.
- ❿ Children under 10 years should not use the printer without supervision.
- ⓫ Tips Do not plug or unplug the power cord when power on.
- ⓬ Users should comply with the laws and regulations of the corresponding countries and regions where the equipment is located (used), abide by professional ethics, pay attention to safety obligations, and strictly prohibit the use of our products or equipment for any illegal purposes. Creality will not be responsible for any violators' legal liability under any.

Equipment Introduction	01-01
Equipment Parameters	02-02
Parts List	03-03
Use the 3D Printer	04-10
Print Method	11-13
Clean the Resin Vat	14-14
Wiring Connection	15-16
Troubleshooting	17-17

1. Equipment Introduction

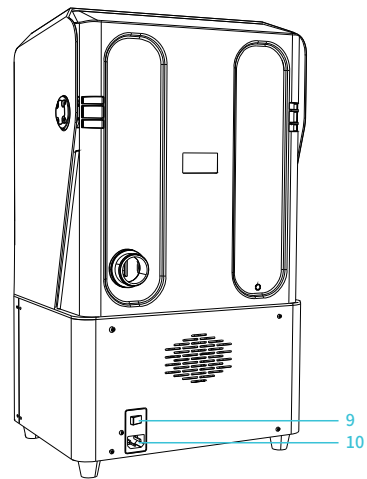
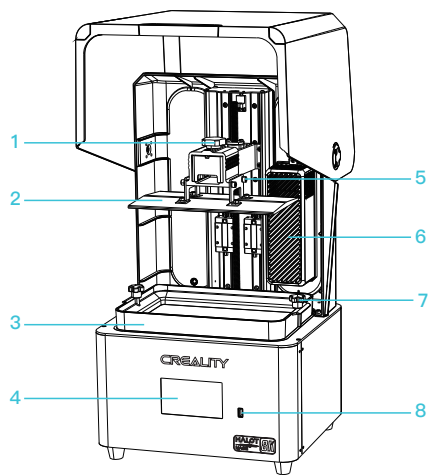

1 Hexalobular socket screw

2 Buliding platform

3 Resin vat

4 Touch screen

5 Leveling screw

6 Air filter

7 Hexalobular socket screw

8 USB port

9 Power switch

10 Power socket

2. Equipment parameters



Basic Parameters

Model Name	HALOT-MAGE
Build Size	228*128*230mm (length*width * height)
Screen Resolution	7680*4320
Pixel Size	0.0297mm
Print Speed	1-5s/layer
Layer Thickness	0.05-0.15mm
Print Screen	10.3" print screen
Light Source Type	3rd generation LCD integral light source
Rated Voltage	100-240V~, 50/60Hz
Rated Power	100W
Machine Size	333*270*608mm
Package size	420*350*675mm
Net Weight	11.7kg
Gross Weight	14kg
Operating Temperature	0~40°C
Print Method	USB Disk
Machine Language	中文 / English
Slicing Software Operation System	Window 7 and above 64-bit operating systems and Mac systems
Compatible Resin	Common rigid photosensitive resin, Standard resin, High hardness, High toughness, Dental model resin.

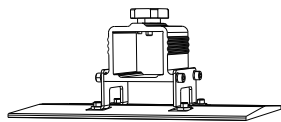

1 Print platform ×1



2 Resin vat ×1

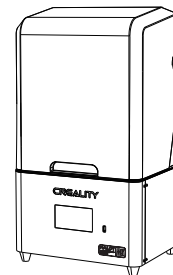

3 3D printer ×1



Tool list



1 U disk ×1



2 Screwdrivers ×1 1set



3 Power cable ×1



4 Paper funnel



5 Plastic blade ×1



6 Metal blade ×1



7 Release film ×1



8 Calibration card ×1



9 Vent-pipe x 1

Tips: the above accessories are for reference only please refer to the physical accessories!

4. Interface Information

Tools

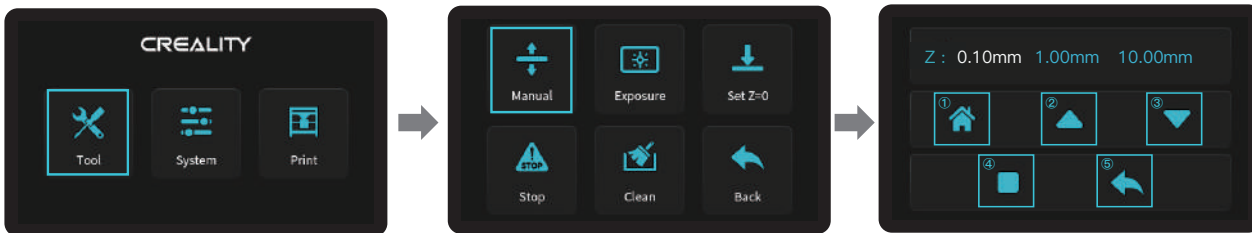

E-stop: When the platform is in the process of rising or falling, click [E-stop] to forcibly stop the platform from rising or falling (this feature is mainly used to prevent damage to the equipment caused by operational errors when there are foreign objects on the platform and in the trough).

- 1 Auto Homing
- 2 Up
- 3 Down
- 4 Stop
- 5 Back

Exposure

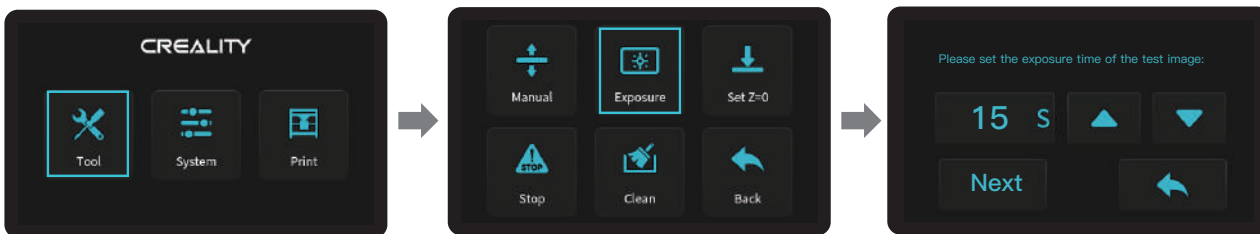

Note: If the exposure graph does not match the example graph, please contact our customer service staff.



Note: The current interface is for reference only, due to the continuous upgrading of functions, the actual to the official website of the latest firmware UI as the standard.

System

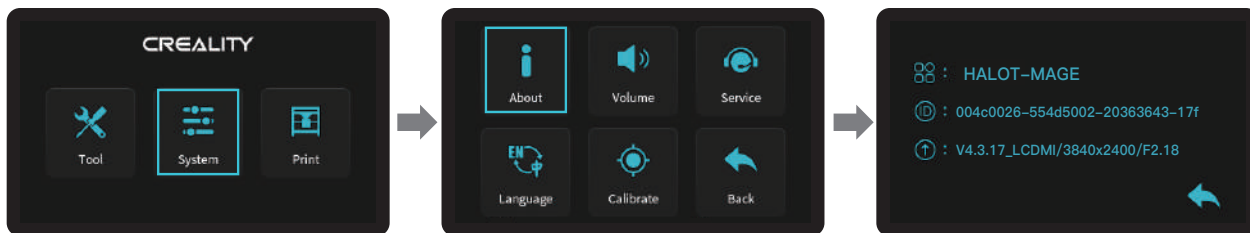

Calibrate

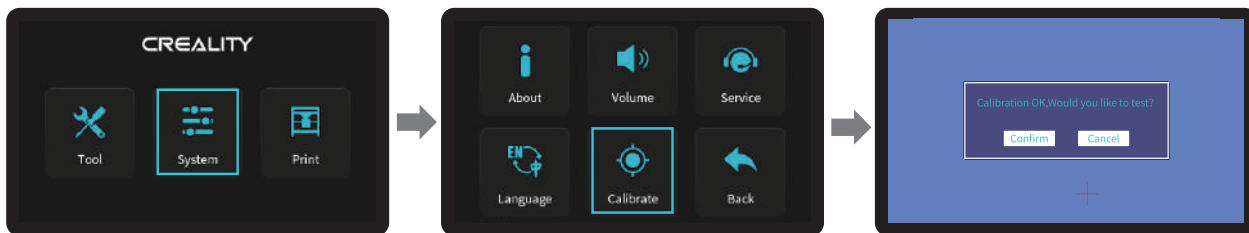

Make corrections by clicking on the "+" sign on the screen and then click "OK" to enter the test.



Note: If a correction action cannot be performed, please contact our customer service staff.



Note: The current interface is for reference only, due to the continuous upgrading of functions, the actual to the official website of the latest firmware UI as the standard.



Print

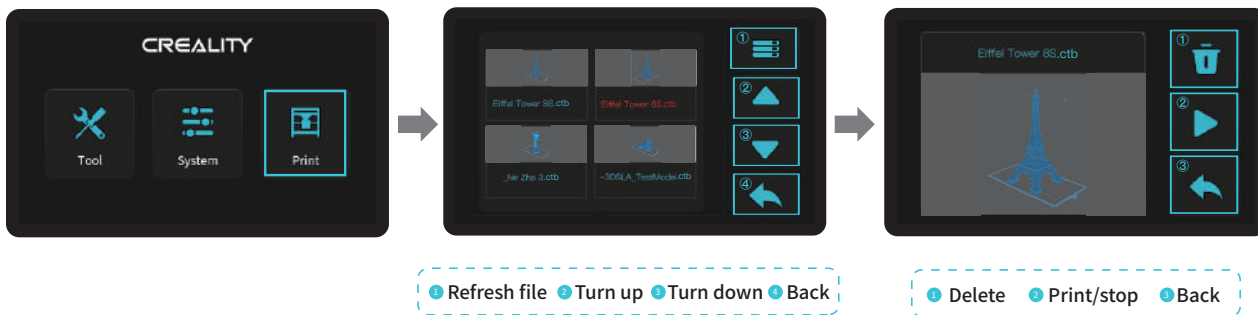

Note: The current interface is for reference only, due to the continuous upgrading of functions, the actual to the official website of the latest firmware UI as the standard.

5. Leveling Platform

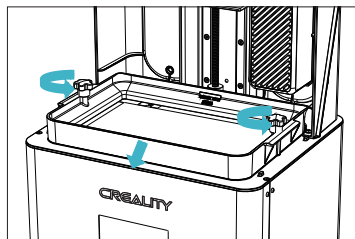

1. Raise the platform, loosen rubber screws on the left and right sides of the resin vat, and take out the resin vat.

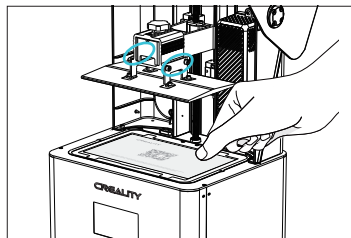

2. Loosen the four screws of the junction plate of the forming platform plate, press the calibration card against the print screen and press Tools → Manual → Homing to check whether the platform fits evenly with the paper.

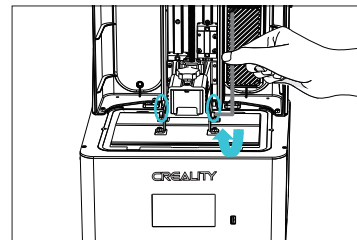

3. After confirming that the calibration card fit evenly, lock the four screws of the platform.



Note: The platform has been leveled at the factory. If it needs leveling due to transportation or other reasons, please follow the steps below to adjust the printing platform.

5. Leveling Platform

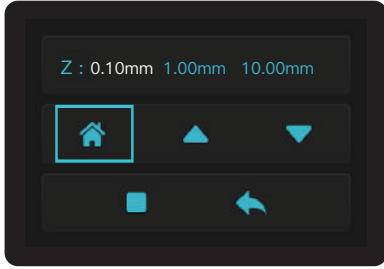

1. After loosening the leveling screws, press the "Homing" on the touch screen to keep the platform balanced with the base plate.

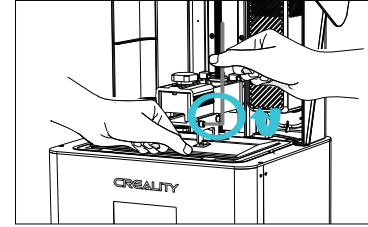
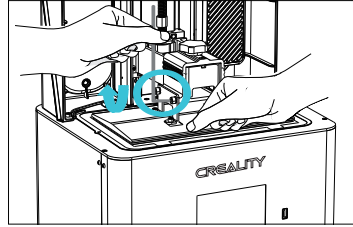

2. Gently press the platform and tighten 4 screws clockwise, and the platform can be leveled successfully.

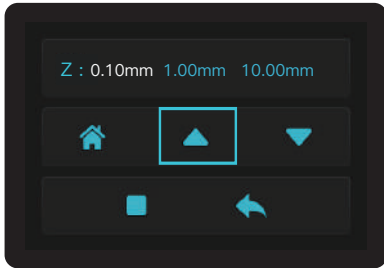

3. Move up the z-axis to a proper position, remove the calibration card and install the resin vat back, and then tighten the fixing screws at both ends of the resin vat.

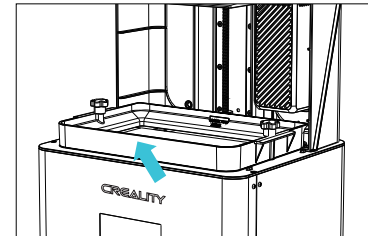
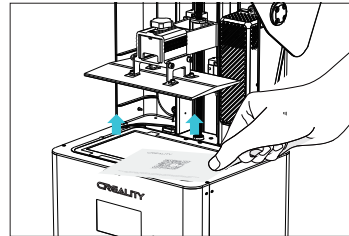

Note: The current interface is for reference only, due to the continuous upgrading of functions, the actual to the official website of the latest firmware UI as the standard.

6. Load Resin

Pour the UV photosensitive resin into the resin vat. The slot capacity is 500ml/1000ml.

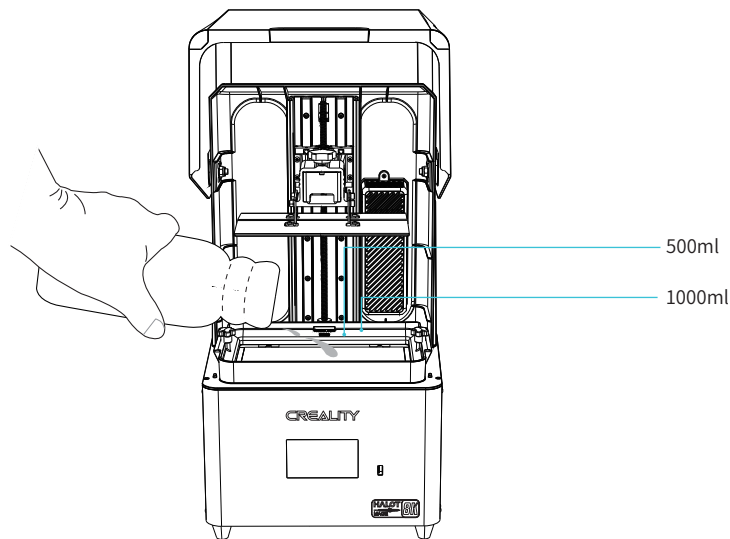

Tips: How to change resin?

Take out the resin vat slowly, pour out the remaining resin into the container, clean the resin vat, pour in new resin, and then install the resin vat to the machine.



Caution:

- ① Resin may cause skin irritation or an allergic skin reaction. Please wear gloves before use to avoid direct contact with the skin.
- ② Do not exceed the maximum capacity scale of the tray when pouring in filaments to prevent them from overflowing during the printing process.

7. Release Film (FEP) Replacement

1

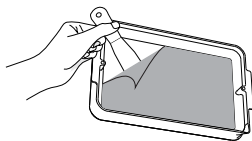

Recycle the resin in the resin vat back into the original bottle, then clean up. (Note: Please make sure there are no residue matter left inside the Vat)

2

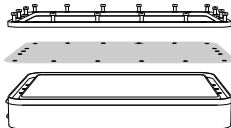

Remove all the screws at the bottom of the resin vat, take out the fixing plate and the release film. (Note: The fixing plate and the vat bottom need to be cleaned)

3

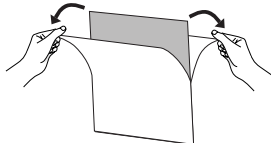

Gently remove the protective film on the front and back of the release film.

4

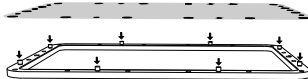

Align the release film positioning holes with the fixing plate positioning posts.

5

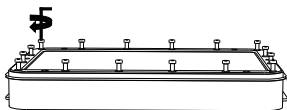

Press into the bottom of the vat, and tighten the screws diagonally across from each other one at a time. (Note: Make sure there are no debris between the fixing plate and release film)

6

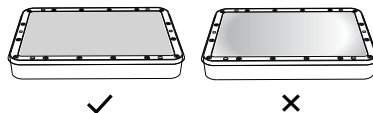

Make sure the release film is flat and tight after installation. (Note: If not flat or loose, please check whether the screws are locked or the release film is abnormal)

Parameters



Size: 286*198mm

THK

Thickness: 0.15-0.2mm



Light Transmittance
95%

- **Tips:** ① The diagram is a reference for the film change procedure, please refer to the physical product; if there are excess edges after installation of the release film, you will need to cut them off.
② It is recommended to replace the release film when it has been used for more than 200 hours.

8. 模型切片准备

1. Slicer

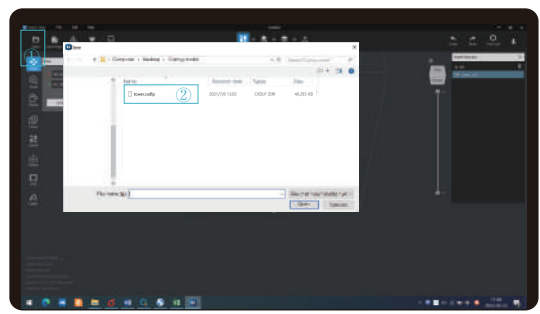

1. Open the slicer software of HALOT BOX, click "Open" on the top left of the screen and add model file;

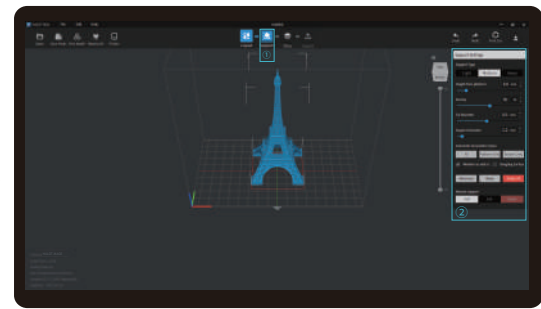

2. If the model needs to add support, click the upper left icon① to set corresponding parameters②.

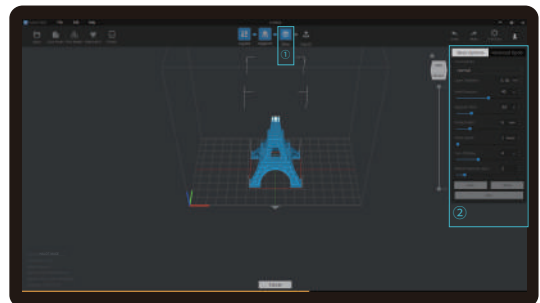

3. Click icon ①→Setting slice printing parameters②→Click

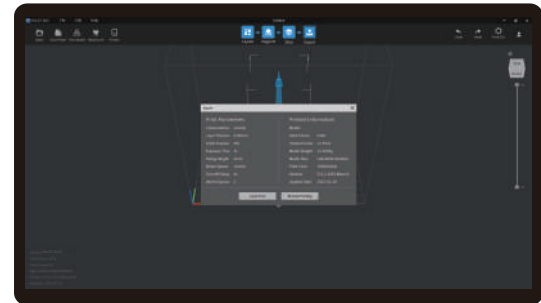

4. wait for slice to be finished→Select "Local Printing" to save the sliced file.



Note: The published UI of slicing software shall prevail for the interfaces of HALOT BOX, LycheeSlicer and CHITUBOX.



2. Print

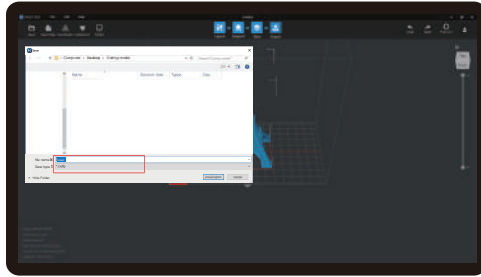

① Generate cxdlp file and save the file to U disk.

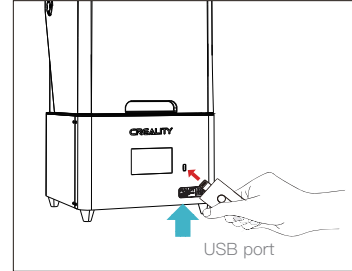

② Insert the USB disk



Note: The current interface is for reference only, due to the continuous upgrading of functions, the actual to the official website of the latest firmware UI as the standard.



Warning: During the printing process the machine can't be shaken, so as not to avoid influencing affect the printing quality.

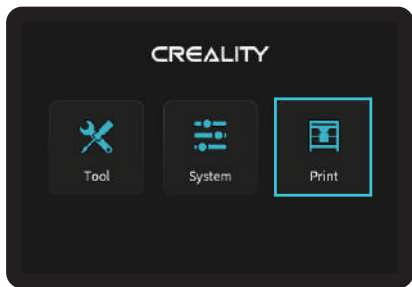

③ Click on "Print"



④ Press "up" or "down" to select files.



⑤ Select the file to be printed and press "print".

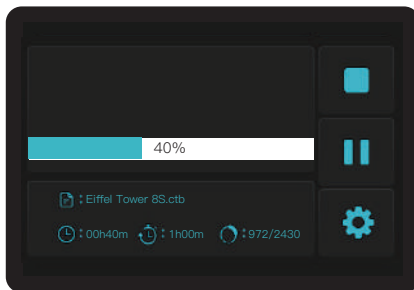

⑥ Printing.



Note: The current interface is for reference only, due to the continuous upgrading of functions, the actual to the official website of the latest firmware UI as the standard.

10. Clean the Resin Vat



*If there is residue in resin vat before printing, please clean resin vat first. The cleaning time is generally set to 15 seconds and then shovel it off with a plastic blade.



Note: The current interface is for reference only, due to the continuous upgrading of functions, the actual to the official website of the latest firmware UI as the standard.

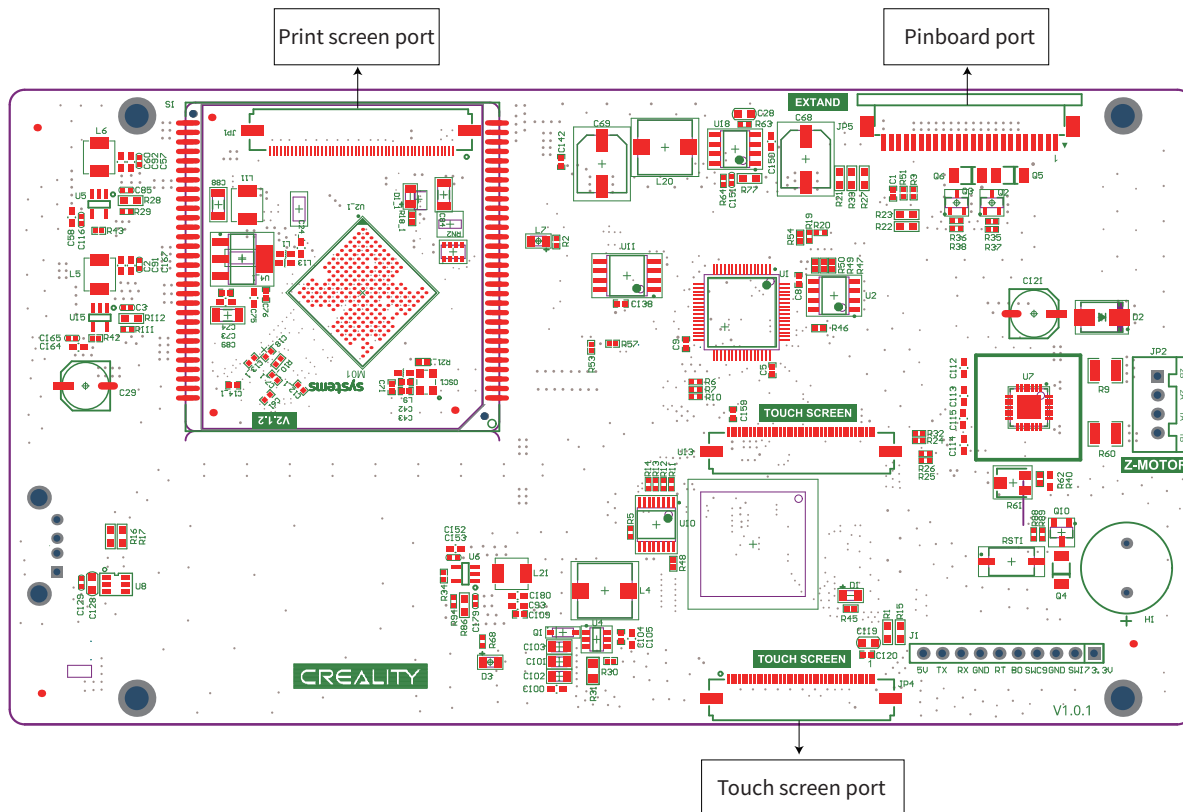

Mainboard circuit wiring diagram

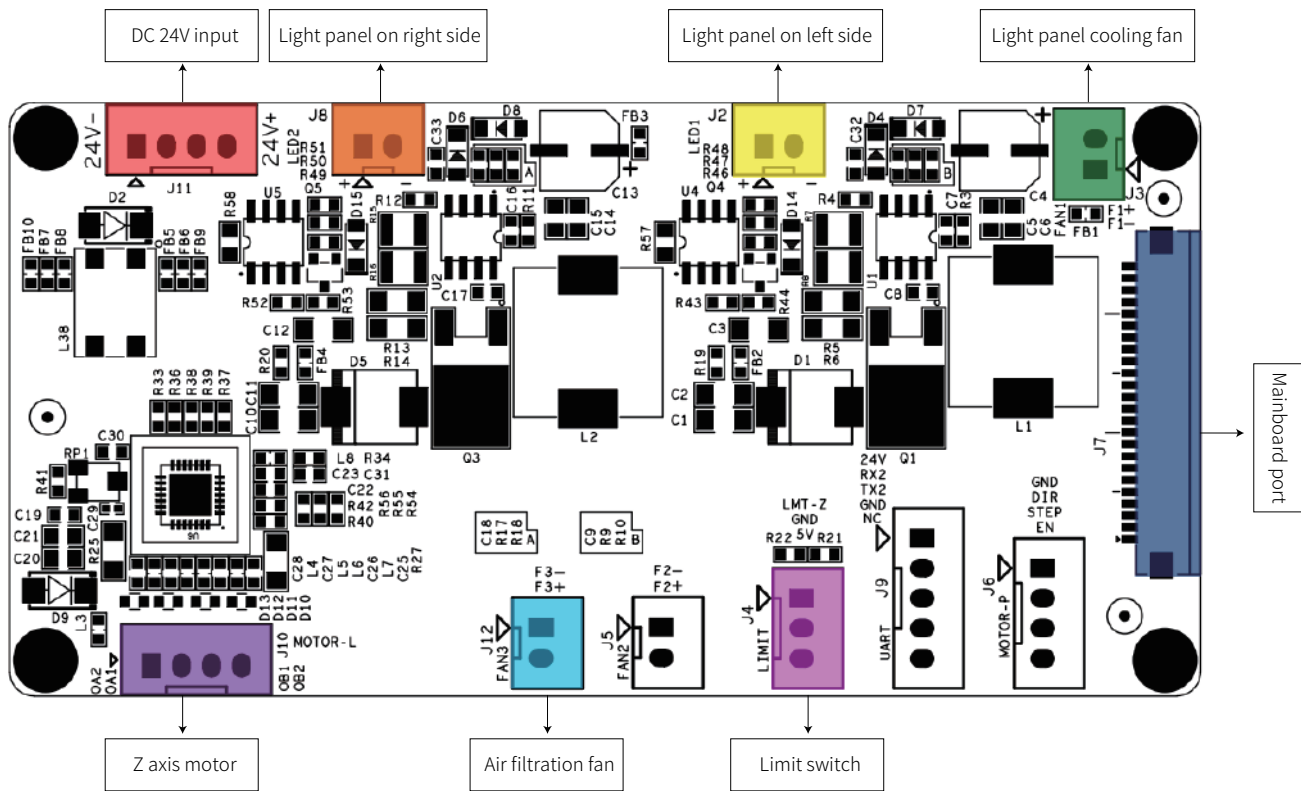

Pinboard circuit wiring diagram

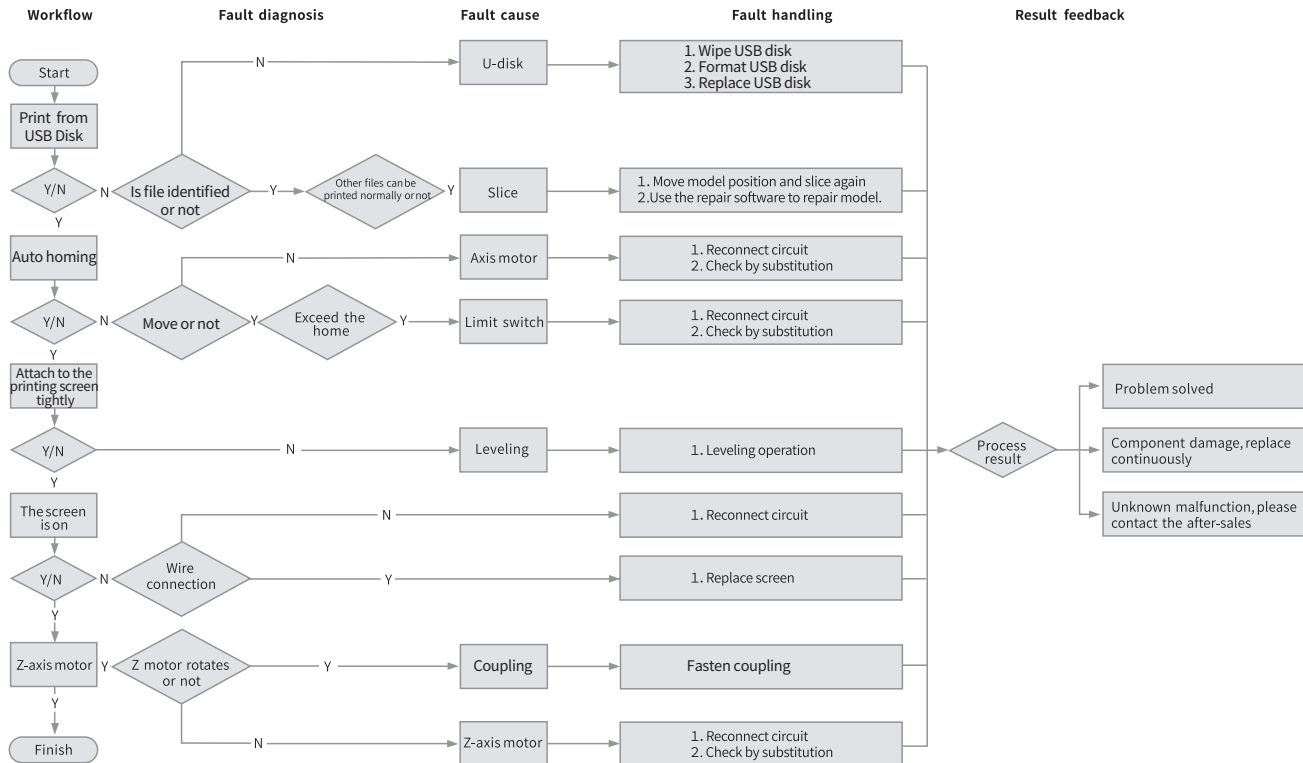

Due to the differences between different machine models, the actual objects and the images can differ. Please refer to the actual machine. The final explanation rights shall be reserved by Shenzhen Creality 3D Technology Co., Ltd.



SHENZHEN CREALITY 3D TECHNOLOGY CO.,LTD.

18th Floor, JinXiuHongDu Building, Meilong Road, Xinniu Community,
Minzhi Street, Longhua District, Shenzhen City, China.

Official Website: www.creality.com

Tel: +86 755-8523 4565

E-mail: cs@creality.com

